

Specification

NO. 20073001				
输出(Output)	Model	ZF120A-2404160		
	DC Voltage	24V		
	Rated current	4.16A		
	Output current range	0~4.16A		
	Rated power(Max)	100W		
	Ripple and noise(Max)	120mVp-p		
	Voltage Tolerance	±5%		
	Line Regulation	±1%		
	Load Regulation	±5%		
Set up, RiseTime	1000ms, 30ms, 50ms/230VAC 1500ms, 30ms, 15ms/115VAC (full load)			
输入(Input)	Voltage Range	85~264VAC		
	Frequency Range	47~63Hz		
	Efficiency	88.0%		
	PF	0.6-0.7		
	AC current	MAX 2.0A/115VAC; 230VAC		
	Inrush current (Max)	35A/115VAC 65A/230VAC		
	Leakage Current (Max)	0.75mA/240VAC		
保护(Protection)	Short circuit protection	The power supply shall not be damaged by short between DC output and DC ground The power supply shall automatically restart when short to ground are removed		
	Overvoltage	110%~140% Rated output voltage Protection type: Diode clamp, output short circuit		
	Overcurrent	Protection type: Hiccup Mode; 5.2A-6.4A overcurrent protection at 220VAC Input voltage		
环境(Environment)	Operating temperature	-30~+45°C		
	Operating Humidity	20~90%RH, (Non-condensing)		
	Storage temperature, Hum	-40~+85°C, 10~95%RH		
	TEMP.Coefficient	±0.03%/°C (0~50°C)		
	Shock	10~500Hz, 2G 10Minute/Period, Period:60minute,along X、Y、Z		
电磁兼容安全标准 (Safety Standards electromagnetic compatibility)	Safety Standards	UL CLASS 2 FCC RoHS...		
	Pressure	I/P-O/P: 4242VDC, I/P-FG: 2121VDC		
	Insulation resistance	I/P-O/P, I/P-FG: 100M Ohms/500VDC/25°C/70%RH		
	EMC Emission	Parameter	Standard	Test Level/Note
		Conducted emission	EN55032(CISPR32),FCC PART 15/CISPR22 CAN ICES-3(B)/NMB-3(B),CNS13438,GB17625.1	Class B
		Radiated emission	EN55032(CISPR32),FCC PART 15/CISPR22 CAN ICES-3(B)/NMB-3(B),CNS13438,GB17625.1	Class B
		Harmonic current	EN61000-3-2,GB9254	Class A
		Voltage flicker	EN61000-3-3
	EMC immunity	Parameter	Standard	Test Level/Note
		ESD	EN61000-4-2	Level 3, 8KV air; Level 2, 4KV contact
		RF field susceptibility	EN61000-4-3	Level 2,3V/m
		EFT bursts	EN61000-4-4	Level 2,1KV
		Surge susceptibility	EN61000-4-5	Level 4,2KV/Line-line,4KV/Line-FG
		Conducted susceptibility	EN61000-4-6	Level 2,3V
		Magnetic field immunity	EN61000-4-8	Level 2,3A/m
Voltage dips, interruption	EN61000-4-11	>95% dip 0.5 periods,30% dip 25 periods,		
其他(Other)	MTBF	≥50Khrs MIL-HDBK-217F(25°C)		
	Size	153*60*38mm(L*W*H)		
	Package	40PCS/CARTON		
	DC Plug	5.5*2.5*11mm / 5.5*2.1*11mm		
备注(Note)	<p>1. Unless otherwise specified, all specifications are measured at 230VAC, rated load, and 25°C 70% RH.</p> <p>2. DC voltage measurement method: measure at the socket terminal point under 50% load condition.</p> <p>3. Ripple and noise measurement method: use a 12" twisted pair cable, and the terminal should be connected with 0.1uf and 47uf capacitors in parallel, and measure at 20MHz bandwidth.</p> <p>4. Accuracy: Includes setting error, linear adjustment rate and load adjustment rate.</p> <p>5. Linear adjustment rate measurement method: from low voltage to high voltage test under rated load.</p> <p>6. Load regulation measurement method: 10%-100% from the rated load.</p>			

■ 减额曲线

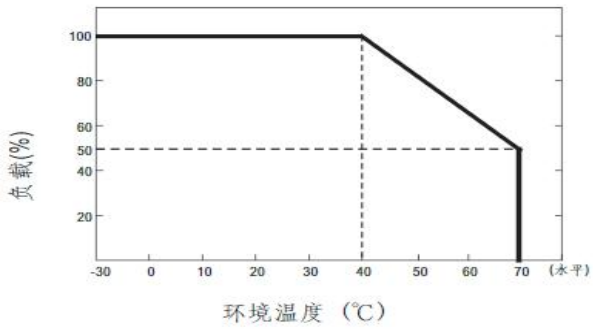

■ 静态特性曲线

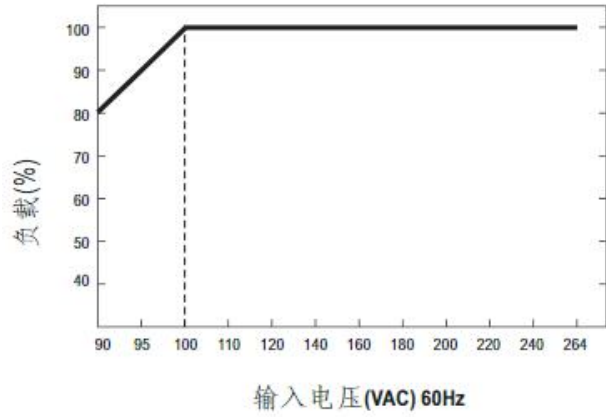

■ 机构尺寸(Dimension)

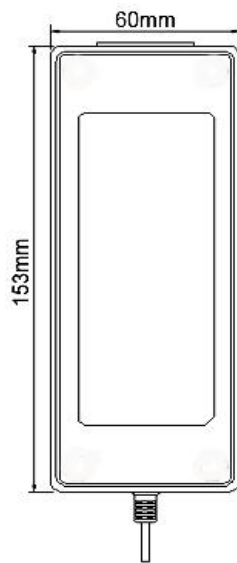
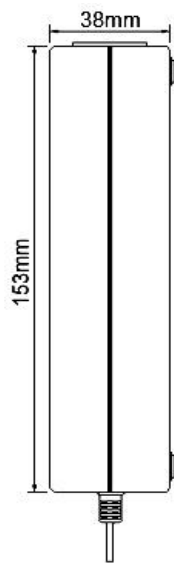
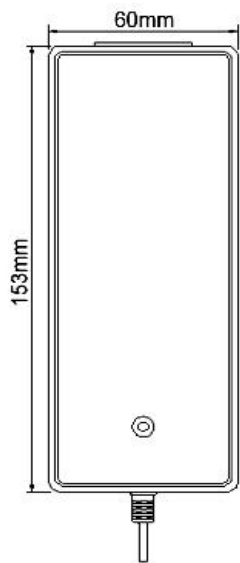

AC座(AC Inlet):

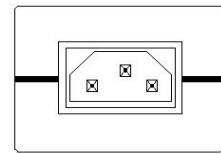

C14

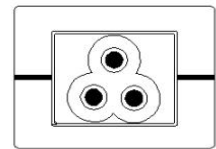

C6

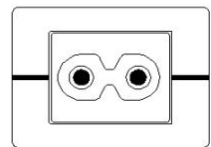

C8

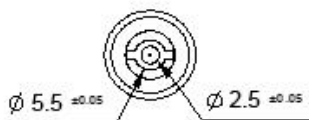
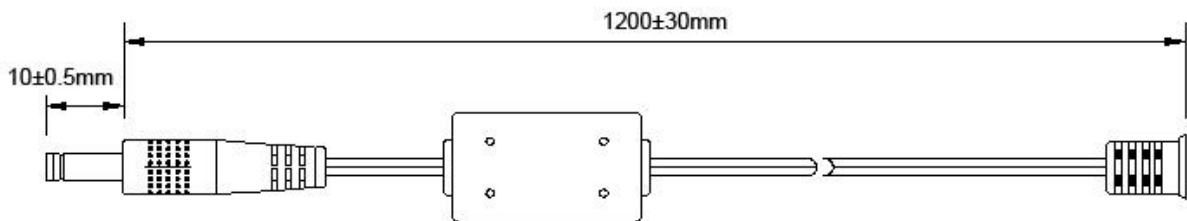

■ 输入插头(AC Plug optional)

中国/CHINA

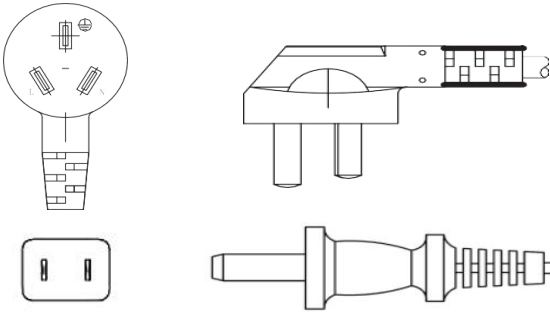

美国/NORTH AMERICA

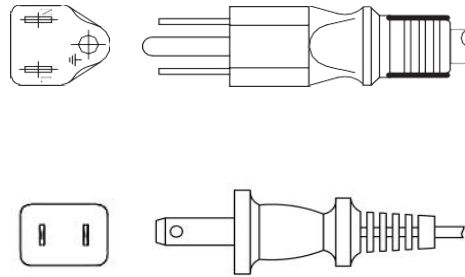

欧洲/EUROPE

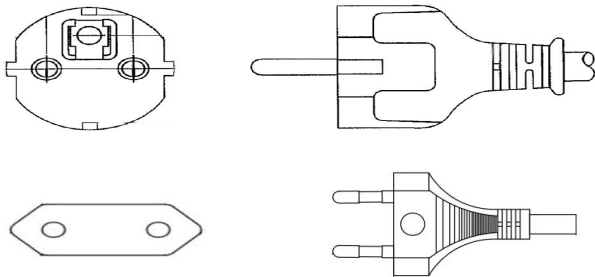

澳大利亚/AUSTRALIA

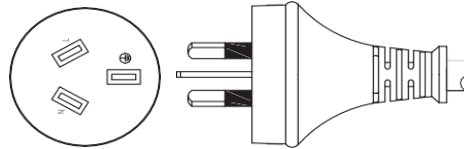

英国/UNITED KINGDOM

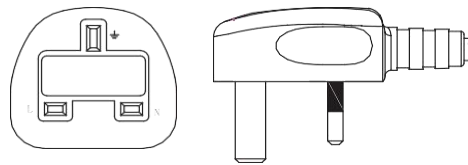

巴西/BRAZIL

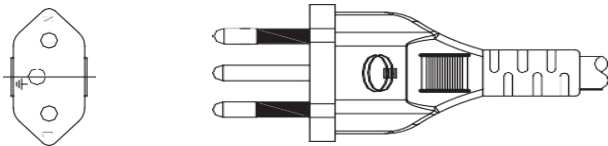

南非/SOUTH AFRICA

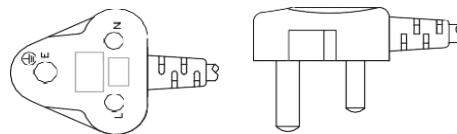

韩国/SOUTH KOREA

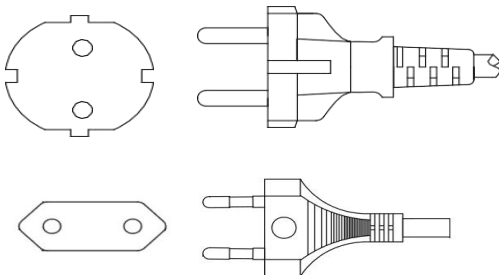

日本/JAPAN

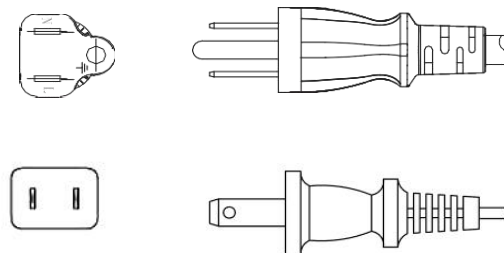

■ 装箱信息 (Package)

重量/weight: 0.45kg/PCS (not including AC cable)

外箱/outer package: 52*50*22CM

包装/package: 40PCS/CARTON

极性: 内正外负

Polarity: Center Positive



■电源 (Product)

